

ZEROTECH

INSTRUCTION MANUAL

ZEROTECH RIFLESCOPES

THRIVE / THRIVE HD / TRACE / TRACE ADV

WARNING

KEEP BATTERIES OUT OF REACH OF CHILDREN



**THIS PRODUCT MAY CONTAIN A COIN BATTERY.
THE BATTERY CAN CAUSE SEVERE OR FATAL INJURIES IN
2 HOURS OR LESS IF IT IS SWALLOWED OR PLACED
INSIDE ANY PART OF THE BODY.**

CONTENTS

PAGES

- | | | | |
|-----------|-------------------------------------|-----------|-----------------------------------|
| 4 | INTRODUCTION | 25 | ILLUMINATION FEATURE |
| 5 | LIFETIME WARRANTY | 27 | LENS COVER &
TURRET MULTI-TOOL |
| 6 | SCOPE FEATURES | 31 | SCOPE CARE |
| 8 | SETTING THE DIOPTRE | 32 | RETICLES |
| 10 | MOUNTING YOUR SCOPE | 34 | WARRANTY INFORMATION |
| 12 | ADJUSTING PARALLAX | | |
| 14 | ZEROING YOUR RIFLE | | |
| 17 | LOCKING WINDAGE & ELEVATION TURRETS | | |
| 21 | ZEROING THE WINDAGE TURRET | | |
| 23 | THRIVE & THRIVE HD MODELS | | |

INTRODUCTION

WELCOME TO THE ZEROTECH RIFLESCOPE FAMILY!

Customer First - We listened to you and came up with a family of riflescopes that will satisfy the needs of our most discerning and experienced customers.

Backed by Experience - ZeroTech enjoys 55 years of experience in the Optics Market supplying high quality brands to retailers throughout Australia and the Asia Pacific.

Built for the Australian Shooter - Designed and built to endure the harsh conditions of the Australian bush and the exacting demands of the precision shooter.

Lifetime Warranty - Be safe in the knowledge that your scope is backed by our Triple A Lifetime Warranty: **'ANY OWNER, ANY PROBLEM, ALWAYS COVERED'**

Bespoke Reticles - Practical reticles for the everyday shooter. Helping you put rounds on target!

LIFETIME WARRANTY

BACKED FOR LIFE!

Be safe in the knowledge that your scope is backed by our **Triple A Lifetime Warranty**:

- Fully transferable, covers accidental damage as well as defects in materials and workmanship.
- No receipt or warranty card is required.
- We will repair or replace product with equal or similar value and/or specifications.
- We will return product to you at no charge.



LIFETIME WARRANTY

**'ANY OWNER, ANY PROBLEM,
ALWAYS COVERED'**

SCOPE FEATURES

TRACE & TRACE ADVANCED FEATURES

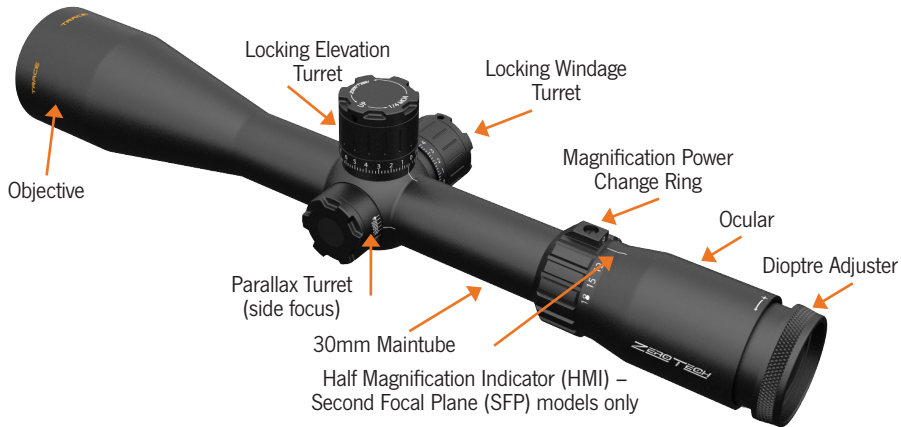

THRIVE & THRIVE HD FEATURES



SETTING THE DIOPTRE

BEFORE YOU START USING YOUR SCOPE, IT IS EXTREMELY IMPORTANT TO MAKE SURE YOU HAVE ADJUSTED THE DIOPTRE CORRECTLY. THE CORRECT DIOPTRE SETTING WILL ENSURE THAT YOUR RETICLE REMAINS CLEAR AND SHARP THROUGHOUT THE ENTIRE FOCAL RANGE OF YOUR SCOPE. TO SET YOUR DIOPTRE, FOLLOW THE STEPS BELOW;

1. Set your magnification to the maximum power.
2. If fitted, set the parallax turret to the infinity marker.
3. Find a blank, featureless and bright surface, such as a white wall or clear blue sky and look through your scope for no more than 5 seconds at a time.

NEVER LOOK THROUGH YOUR SCOPE DIRECTLY AT THE SUN.

4. When briefly looking through the scope, the reticle should appear sharp and clear immediately. If the reticle is not immediately sharp and clear, twist the dioptre adjuster to bring the reticle into sharp focus. The dioptre adjuster has approximately $1\frac{3}{4}$ turns of adjustment. We recommend starting with the dioptre assembly twisted flush up against the ocular and making adjustments in an anticlockwise (towards the + symbol marked on the ocular) direction until the optimal setting is reached.
5. Once you have established your dioptre setting, make note of the position of the dioptre for future reference. You will not need to make frequent adjustments to your dioptre unless your setting is disturbed or changed by someone else.



MOUNTING YOUR SCOPE

BEFORE MOUNTING YOUR SCOPE TO A FIREARM, IT IS ESSENTIAL THAT YOU CONFIRM THAT YOUR FIREARM IS UNLOADED AND NO AMMUNITION IS PRESENT IN YOUR WORKSPACE.

TO AVOID PERMANENT AND UNECESSARY DAMAGE TO YOUR NEW RIFLESCOPE, IT SHOULD ALWAYS BE MOUNTED BY AN EXPERIENCED PROFESSIONAL.

1. Once you are satisfied the base(s) is correctly fitted to the receiver of your firearm, proceed to fit the rings to the base(s) and ensure the ring clamps are tightened to the recommend torque settings as specified by the manufacturer.
2. With the ring tops removed, place the scope in the ring bases and gently slide the scope back and fourth in the ring bases to ensure the scope slides freely. If the scope does not slide freely, lapping of the rings may be necessary to avoid damage

to the scope maintube. ZeroTech always recommends the use of high quality rings and bases to ensure the best possible fitting of your scope.

3. Avoid mounting the scope with the rings contacting the junction of the maintube/erector housing, magnification ring/maintube junction or the objective/maintube junction.
4. It is essential to confirm that no part of the scope is contacting the barrel or receiver when the scope is mounted in the rings.
5. Once you have confirmed the fit of the scope in the ring bases, fit the ring tops and tighten the ring top bolts to between 22 – 25 in lbs or 2.5 – 2.8NM.
6. ZeroTech highly recommends the use of a scope level (bubble level) fitted to the rings or the scope maintube to ensure the reticle can consistently be aligned with the fall of gravity every time a shot is fired. This is particularly important for precision shooting applications.

*If your level mounts to the maintube of the scope, follow the same guidelines as observed for scope ring fitting to ensure the level does not damage the maintube of your scope.

ADJUSTING PARALLAX

If your ZeroTech scope is fitted with a parallax turret, it is important to adjust the parallax turret for shots taken at different distances. Some shooters refer to the parallax turret as the 'side focus'. It is referred to as the 'side focus' because by turning the turret, it will bring your target image into focus. As a general rule and as long as your dioptre is set correctly (refer to page 8 – 'Setting the Dioptre') the sharper the target image is focused, the parallax error will be less.

Parallax error is quite easy to detect when following the instructions below;

1. Acquire your target image at any distance and make sure your rifle is well supported by the use of a bipod and rear bag (or similar).
2. Use the parallax turret to obtain the sharpest/ clearest possible target image and establish a refined point of aim on the target.
3. Once you have established a refined point of aim and a sharp target image, move

your head gently up and down whilst looking through the scope. Be sure not to disturb the rifle/ sights.

4. If you are able to observe the reticle departing slightly from the intended point of aim, make small adjustments on the parallax turret until the reticle remains fixed on your point of aim.
5. You will need to repeat this process when shooting at different distances or in different environmental conditions.
6. **The distance markings on the parallax turret are intended as a guide only.** Dioptre settings and environmental factors are likely to cause the distance markings to vary in relation to the actual distance of the target.

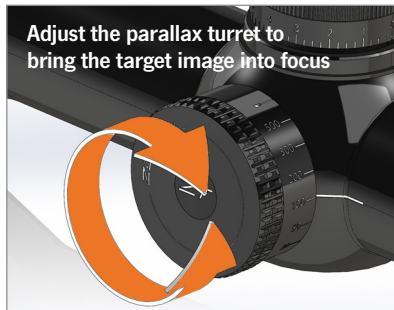

ZEROING YOUR RIFLE

ZEROING DISTANCES

Centrefire rifles: Zerotech recommends zeroing most centrefire rifles at approximately 100 metres +/- 10 metres. 100 metres enables the shooter to overcome any offset problems caused by the centre height of the scope above bore but is not too far as to accidentally build in an error due to unobserved environmental conditions such as wind.

Rimfire rifles: Most commonly, rimfire hunting rifles are zeroed at 50 – 75 metres depending on the type of ammunition being used. Rimfire target rifles may have different zeroing requirements depending on purpose.

We always recommend that you zero your rifle in the same manner as you typically shoot your rifle. For example, if you mainly shoot your rifle from a bench, zero your rifle by shooting from a bench. If you predominately shoot your rifle in the prone position, zero your rifle from the same position.

Before you fire your first shot, you should bore sight your rifle to ensure your scope and your barrel are both aligned at the intended point of impact on your target. To do this with a bolt action rifle, remove the bolt with the rifle securely supported (front and rear) and align the bore with the target.

Without disturbing the rifle, carefully look through the scope and check that the reticle is also aligned with the same point as the bore on the target. If the reticle is not aligned, use the windage and elevation adjustments on your scope to adjust the reticle to the intended point of impact on the target.

Once you are satisfied that the scope and the bore of your rifle are aligned to the same point on the target, fire a shot at the target and observe the point of impact (bullet hole). If required, use the windage and elevation turrets on your scope to adjust the bullet impact.

ZEROING DISTANCES CONTINUED...

Dialling the elevation turret in the direction of the 'U' symbol will adjust the bullet impact upwards on the target. Likewise, dialling the windage turret in the direction of the 'R' symbol will adjust the bullet impact to the right on the target.

- ▲ If your scope turrets are indexed in $\frac{1}{4}$ Minutes of Angle (0.25 MOA), each 'click' of your scope turret will adjust your bullet impact approximately 7-8mm at 100 metres (approx. $\frac{1}{4}$ " at 100 yards).
- ▲ If your scope turrets are indexed in 0.1 Milrad (0.1 MRAD), each 'click' of your scope turret will adjust your bullet impact 1cm at 100 metres (0.36" at 100 yards).

LOCKING WINDAGE AND ELEVATION TURRETS*

SETTING THE ELEVATION ZERO STOP

Once you have established a zero for your rifle, the zero stop feature can be set to ensure a consistent return to zero after dialling the elevation turret to compensate for shots taken at distances other than that of your confirmed zero.

SETTING THE ZERO STOP

1. Remove the elevation turret by loosening the three (3) opposing grub screws located in the top of the elevation turret with a 2mm hex key. Remove the elevation turret and set aside.

*(TRACE AND TRACE ADV MODELS ONLY)



2. With the elevation turret removed, the orange zero stop ring will be visible. Similar to the elevation turret cap, the orange zero stop ring also has three (3) opposing grub screws. Use your 2mm hex key to loosen the grub screws 1 to 2 revolutions each. This will allow the orange zero stop ring to spin freely.
3. Slide the orange zero stop ring downwards until it stops. During this process, it is important to note the small black lug located on side of the orange zero stop ring. There is also a lug located the top face of the lower assembly, directly underneath the orange zero stop ring. **It is critical that the lug on the side of the orange zero stop ring is positioned on the right hand side of the lug on the lower assembly.** Failure to follow this step will result in the elevation adjustment being locked out and unusable until the zero stop is reset. If this occurs, simply position the lug on the orange zero stop ring on the other side of the lug on the lower assembly.
4. Tighten the three (3) 2mm grub screws in the orange zero stop ring. The zero stop is now set.

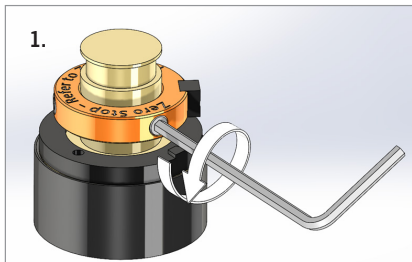

Loosen the three 2mm grub screws in the orange zero stop and slide the zero stop downwards until it stops.

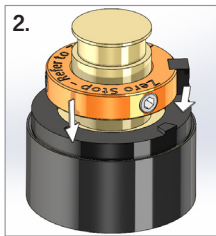

SETTING THE ZERO STOP CONTINUED...

The zero stop is now set. Tighten the three 2mm grub screws and replace the elevation turret indexed to the '0' position.

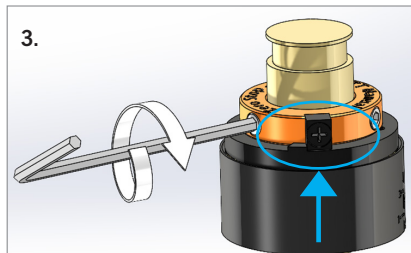

Note the position of the lugs as described in step 3.

5. Replace the elevation turret and make sure to align the '0' on the elevation turret cap to the vertical marker on the lower turret assembly to enable an easy and precise reference when dialling the elevation turret. Tighten the three (3) 2mm grub screws to secure the turret cap. We recommend using the short end of your hex key to apply adequate torque to the grub 2mm grub screws.



ZEROING THE WINDAGE TURRET

1. The windage turret can be reset to '0' without completely removing the windage turret cap from the scope. It is important to note that the windage turret does not have a zero stop feature as the turret needs to be able to adjust the bullet impact both left and right equally at all times.
2. With the windage turret in the unlocked position, loosen the three (3) 2mm grub screws approximately $\frac{1}{2}$ - 1 revolution each. This will allow the windage turret to spin freely.
3. With the windage turret spinning freely, align the '0' on the turret with the index line on the lower turret assembly and tighten the three (3) 2mm grub screws, using the short end of your hex key for adequate leverage.

ZEROING THE WINDAGE TURRET CONTINUED...

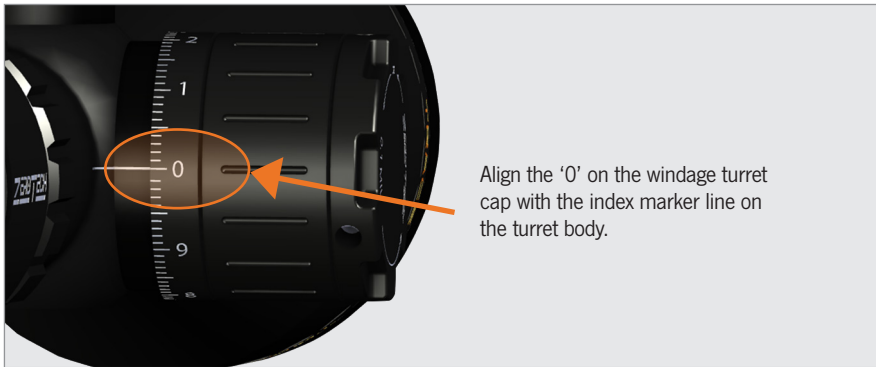

THRIVE & THRIVE HD

RESETTING THE TURRETS AFTER ZEROING

1. After you have followed the mounting and zeroing instructions on pages 14 – 16, you are ready to reset the elevation and windage turrets to zero ('0').

Holding the turret in place, use the ZT multi-tool to unscrew the turret keeper anticlockwise. Remove the keeper and the turret. (For more info on ZT multi-tool see page 27).

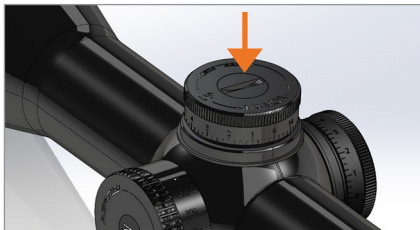

Replace the turret with the reference set to '0' (zero). Replace and tighten the keeper using the ZT multi-tool. It is not necessary to overtighten the keeper.

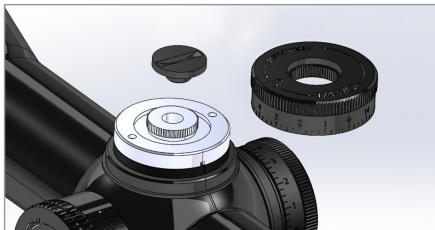

RESETTING THE TURRETS AFTER ZEROING CONTINUED...

2. Check your turret to make sure the '0' on the turret is aligned with the index mark on the turret body



Make sure the '0' marker aligns with the index marker on the turret body.

3. Repeat this process for the windage turret.
4. Replace the turret caps to ensure your zero settings aren't disturbed.

ILLUMINATION FEATURE

Thrive HD models fitted with the push button illumination function have 6 settings (5 illumination settings + OFF setting).

1. Before use, install the CR2032 battery by removing the illumination turret battery cover. Unscrew in an anticlockwise direction.
2. Press the illumination control button once to illuminate the reticle. You can then toggle between the brightness settings by quickly pressing the button.
3. IMPORTANT - To turn the reticle illumination off, press and hold the button for 2 – 3 seconds.
4. Models fitted with the push button illumination have an auto shutdown feature. The reticle will automatically power-off after 3 hours to avoid excessive battery consumption.
5. Our push button illumination has a memory function that resumes on the same brightness setting the next time the illumination is activated.

ILLUMINATION FEATURE CONTINUED...



BATTERY REPLACEMENT

Unscrew battery cap anticlockwise.

Insert battery and replace illumination turret cap.

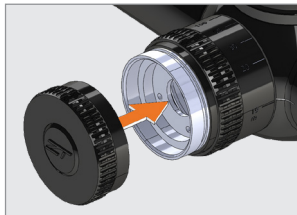

WARNING
KEEP BATTERIES OUT OF REACH OF CHILDREN



THIS PRODUCT CONTAINS A COIN BATTERY.
THE BATTERY CAN CAUSE SEVERE OR FATAL INJURIES IN
2 HOURS OR LESS IF IT IS SWALLOWED OR PLACED
INSIDE ANY PART OF THE BODY.

WARNING – KEEP BATTERIES OUT OF REACH OF CHILDREN

Zerotech rifle scopes and optics with a reticle illumination feature contain coin batteries. Products containing coin batteries must be kept out of reach of children. The battery can cause severe or fatal injuries in 2 hours or less if it is swallowed or placed inside any part of the body. If you suspect your child has swallowed or inserted a button battery immediately call the 24-hour Poisons Information Centre on 13 11 26 (Australia) for fast, expert advice.

ZEROTECH LENS COVER AND TURRET MULTI-TOOL

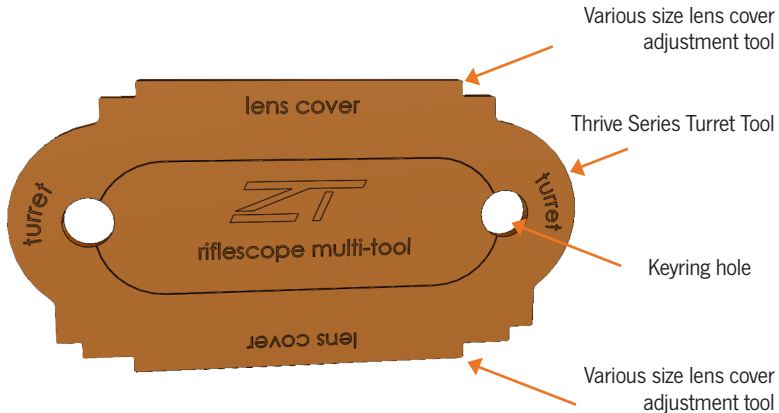

ADJUSTABLE FLIP UP LENS CAPS

(THRIVE HD AND TRACE MODELS)

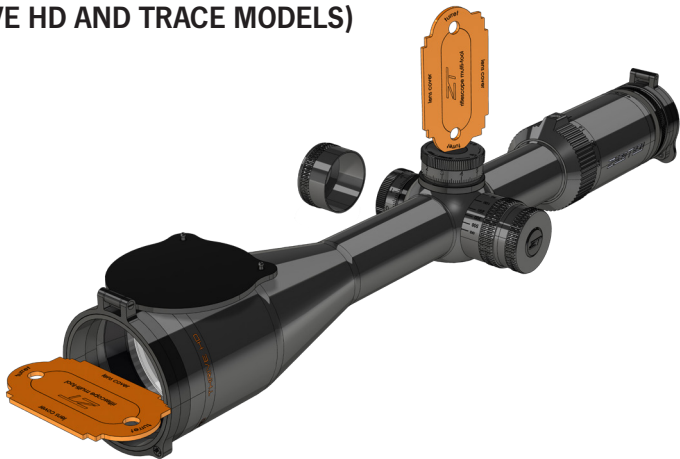

Zerotech Thrive HD and Trace models are fitted with **HD Alloy Flip Up lens covers**. The HD Alloy lens covers are removable and can be rotated to the preferred position of the shooter. For example, some shooters prefer their objective flip up cover to fold out to the side of the scope instead of folding to the top.

It is likely that you will also need to adjust the position of the ocular flip up cover after you have obtained the correct dioptre setting (as described on page 8).

To adjust the position of the flip up lens covers, follow the steps below:

1. Select the end of the multi-tool that fits the slots in the lock ring of your lens cover
2. Loosen the lens cover lock ring by twisting the multi-tool in an anticlockwise direction
3. Rotate the lens cover to the desired position
4. Tighten the lens cover lock ring but twisting the multi-tool in a clockwise direction

If you wish to completely remove the flip up lens covers, simply use the multi-tool to rotate the lens cover lock ring in an anticlockwise direction until the lens cover completely detaches from the scope.

USING THE ZERO TECH MULTI-TOOL TO RESET THE ELEVATION AND WINDAGE TURRETS (THRIVE SERIES ONLY)

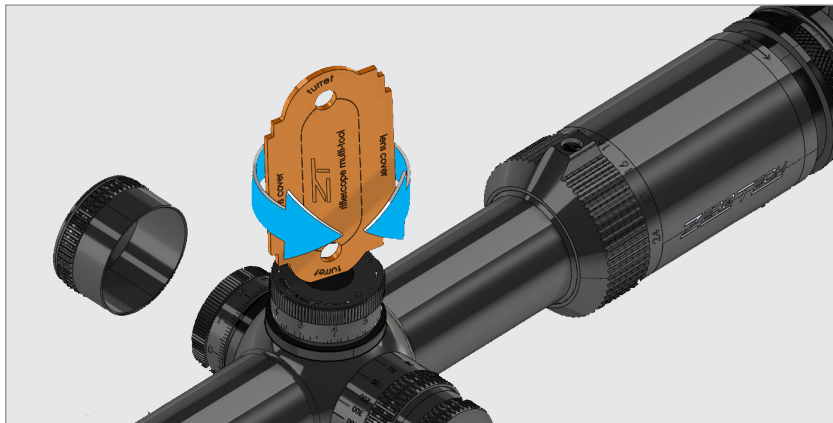

RESET THE ELEVATION AND WINDAGE TURRETS

Once you have zeroed your rifle at the desired distance, it is recommended that you reset your elevation and windage turrets back to '0'. This gives the shooter the ability to use the turrets to precisely dial elevation and windage onto the scope when shooting at distances other than the zero distance for the rifle.

To reset the turrets on the Thrive and Thrive HD models, you will require the Zerotech multi tool (or a coin). Follow the steps below.

1. Holding the turret firmly, insert the multi tool into the slot in the turret centre bolt and completely remove the centre bolt but twisting the multi tool in an anticlockwise direction.
2. Once the centre bolt has been removed, simply lift the turret away from the scope.
3. Refit the turret to the scope, making sure to align the '0' marking on the turret with the index line on the scope body.
4. Hold the turret firmly and tighten the centre bolt back down by twisting the multi tool in a clockwise direction

ZEROTECH RETICLES

SECOND FOCAL PLANE RETICLES

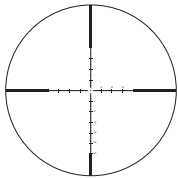

R3

Available in;
TRACE 3-18x50
TRACE 4.5-27x50
THRIVE HD 3-18x56
VENGEANCE 4-20x50
VENGEANCE 4-20x50 Illum.

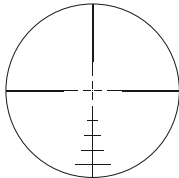

PHR-II

Available in;
THRIVE HD 2.5-15x50
THRIVE HD 2.5-15x50 Illum.
THRIVE HD 6-24x50
THRIVE HD 6-24x50 Illum.
THRIVE HD 3-18x56 Illum.
VENGEANCE 4-20x50
VENGEANCE 4-20x50 Illum.

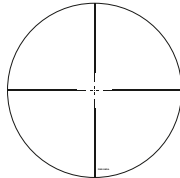

PHR 3

Available in;
THRIVE 3-9x40
THRIVE 3-12x44

ZEROTECH RETICLES

SECOND FOCAL PLANE RETICLES

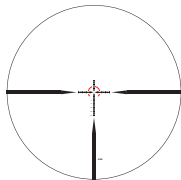

RAR

Available in;
VENGEANCE 1-6x24 Illum.

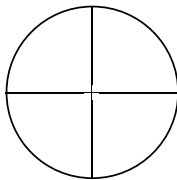

ZEROPLEX

Available in;
THRIVE 3-9x40
THRIVE 3-12x44
THRIVE 4-16x50

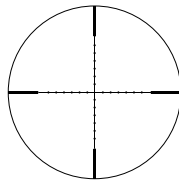

Mildot

Available in;
THRIVE 3-12x44
THRIVE 4-16x50

For specific information on your reticle, refer to the reticle spec sheet provided in your scope box or visit www.zerotech.com.au

ZEROTECH RETICLES

FIRST FOCAL PLANE RETICLES

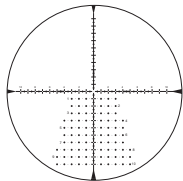

RMG

Available in;
TRACE Advanced 4.5-27x50

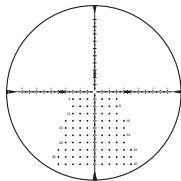

RMG MOA

Available in;
TRACE Advanced 4.5-27x50

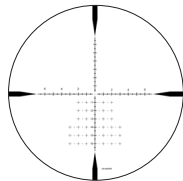

LR HUNTER

Available in;
TRACE Advanced 3-18x50
THRIVE HD - 4-16x44
THRIVE HD - 6-24x50

For specific information on your reticle, refer to the reticle spec sheet provided in your scope box or visit www.zerotech.com.au

SCOPE CARE

1. Wipe dust and debris from your scope body using a damp microfibre cleaning cloth.
2. If necessary, clean dust and dirt from the scope lenses using a lens brush and the ZeroTech lens cleaning cloth.
3. Never spray cleaners or solvents on any part of your scope. Irreversible damage may be caused by such products.
4. Avoid touching the scope lenses. Wipe fingerprints off the scope lenses using the ZeroTech lens cleaning cloth.

WARRANTY INFORMATION

Please direct all enquiries to **service@zerotech.com.au**

Company details;

ZEROTECH INTERNATIONAL PTY LTD

Ph: +612 9938 3244

Email: sales@zerotech.com.au

Address:

PO BOX 7200,
Warringah Mall
NSW, 2100
AUSTRALIA

NOTES

NOTES



www.zerotech.com.au





LIFETIME WARRANTY

'ANY OWNER, ANY PROBLEM, ALWAYS COVERED'

www.zerotech.com.au



ZERO-TECH 2021 | Printed in China | Specifications subject to change without notice